

ADD BALLAST (AS REQUIRED) IN THIS LOCATION TO OBTAIN PROPER C.G. POINT

NOTE: 40-46 ENGINE IS SIDE MOUNTED BE SURE THERE IS PROPER TIP CLEARANCE AT THE FUSELAGE

NOTE: ALL WOOD PARTS ARE BALSA UNLESS NOTED OTHERWISE

© 1964 ALL COMMERCIAL RIGHTS RESERVED

NORTH STAR

A 40-46 POWERED SPORT AMPHIBIAN DESIGN

DESIGNED & DRAWN BY LADDIE MAXLASKO

PLANS BY *Art Toth*

0 1 2 3 4 5 6



H.E

© 1964 ALL COMMERCIAL RIGHTS RESERVED
NORTH STAR
 A 40-46 POWERED SPORT AMPHIBIAN DESIGN
 DESIGNED & DRAWN BY LAOCE VUKLASKO
 PLANS BY Bob Tevlin

SHEET 2 OF 3

PLAN NO. 960

COMPONENT PARTS LEGEND			
NO.	SIZE	MATERIAL	LOCATION
1	1/4" SQ.	SPRUCE	WING
2	1/4" SQ.	SPRUCE	WING
3	1/4" SQ.	SPRUCE	WING
4	1/8" X 1/4"	SPRUCE	WING
5	3/16" X 1/4"	BALSA	WING
6	3/32" SHEET	BALSA	WING
7	3/32" SHEET	BALSA	WING
8	1/8" X 1/2"	BALSA	WING
9	3/8" X 1/2"	HARDWOOD	WING
10	1/8" SHEET	BALSA	FLOAT
11	1/8" SHEET	BALSA	FLOAT
12	1/6" SHEET	BALSA	WING ROOT
13	3/16" SHEET	BALSA	FUSELAGE
14	1/8" SHEET	BALSA	FUSELAGE
15	1/8" SHEET	BALSA	FUSELAGE
16	1/2" Δ STOCK	BALSA	FUSELAGE
17	1/8" SHEET	PLYWOOD	FUSELAGE
18	3/32" SHEET	BALSA	FUSELAGE
19	1/16" SHEET	PLYWOOD	FIN
20	1/4" X 5/16"	BALSA	RUDDER
21	1/8" SHEET	PLYWOOD	FIN
22	1/4" X 3/8"	BALSA	FIN
23	1/8" SHEET	BALSA	FUSELAGE
24	1/4" X 1/2"	BALSA	FIN
25	1/8" X 5/16"	BALSA	FIN
26	1/8" SHEET	BALSA	FIN
27	3/32" SHEET	BALSA	WING
28	3/32" SHEET	BALSA	WING
29	3/32" X 1/2"	BALSA	WING
30	BLOCK	BALSA	FUSELAGE
31	3/16" SHEET	BALSA	FUSELAGE
32	1/8" SHEET	BALSA	FUSELAGE
33	1/2" Δ STOCK	BALSA	ENGINE POD
34	1/4" SHEET	BALSA	ENGINE POD
35	1/4" SHEET	BALSA	ENGINE POD
36	1/4" SHEET	BALSA	ENGINE POD
37	1/4" SHEET	BALSA	STABILIZER
38	1/4" SHEET	BALSA	TOP FIN
39	1/4" SHEET	BALSA	ELEVATOR
40	3/32" SHEET	BALSA	RUDDER
41	1/8" SHEET	PLYWOOD	RUDDER
42	1/8" SHEET	BALSA	RUDDER
43	1/4" SHEET	PLYWOOD	RUDDER
44	1/8" SHEET	BALSA	RUDDER
45	1/8" SHEET	BALSA	FLOATS
46	1/8" SHEET	BALSA	FLOATS
47	1/8" SHEET	BALSA	FLOATS
48	1/2" Δ STOCK	BALSA	FLOATS
49	1/16" SHEET	PLYWOOD	FUSELAGE
50	1/8" X 1/4"	BALSA	WING ROOT
51	3/8" X 2"	BALSA	AILERON STOCK
52	1/2" Δ STOCK	BALSA	FUSELAGE
53	1/16" SHEET	BALSA	WING
54	3/16" SHEET	BALSA	FUSELAGE
W1-W8	3/32" SHEET	BALSA	WING
F1	1/4" SHEET	BALSA	FUSELAGE
F2	1/4" SHEET	PLYWOOD	FUSELAGE
F3-F7	1/8" SHEET	BALSA	FUSELAGE
P1-P2	1/8" SHEET	BALSA	FIN
E1	1/4" SHEET	PLYWOOD	ENGINE POD

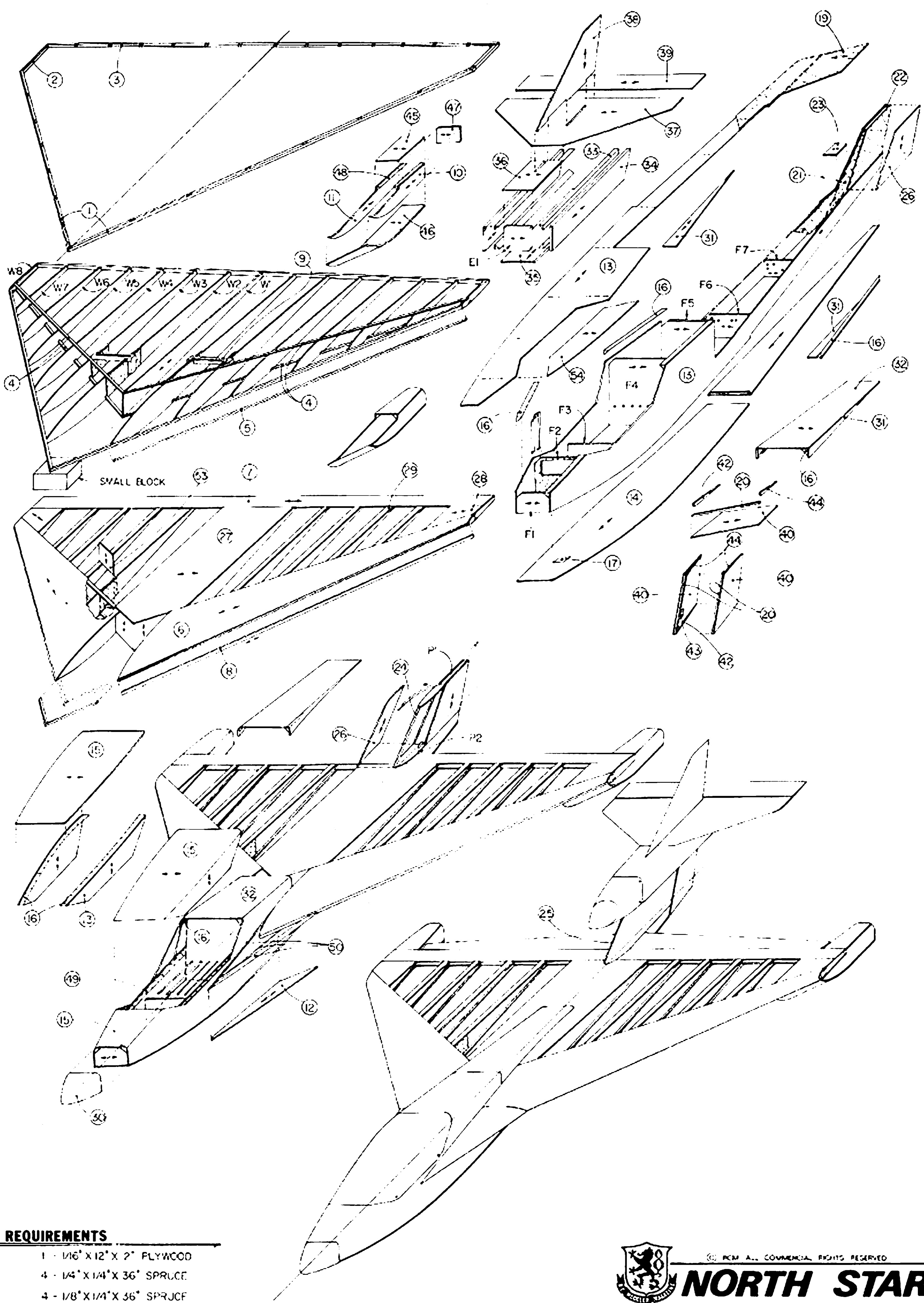

BUILDING MATERIAL REQUIREMENTS

- | | |
|---|---|
| 14 - 3/32" X 3" X 36" BALSA SHEETS | 1 - 1/16" X 12" X 2" PLYWOOD |
| 3 - 3/16" X 4" X 48" BALSA SHEETS | 4 - 1/4" X 1/4" X 36" SPRUCE |
| 4 - 1/2" Δ STOCK X 36" BALSA | 4 - 1/8" X 1/4" X 36" SPRUCE |
| 1 - 1/4" X 4" X 7" PLYWOOD | 2 - 3/8" X 1/2" X 36" BALSA TRAILING EDGE STOCK |
| 2 - 1/4" X 4" X 36" BALSA SHEETS | 1 - 1/16" X 3" X 36" BALSA SHEET |
| 3 - 1/8" X 4" X 36" BALSA SHEETS | 1 - 5/32" DIA X 36" MUSIC WIRE |
| 1 - 1/4" X 2" X 36" BALSA TRAILING EDGE STOCK | |



© 1964 ALL COMMERCIAL RIGHTS RESERVED

NORTH STAR

A 40-46 POWERED SPORT AMPHIBIAN DESIGN

DESIGNED & DRAWN BY
LADDIE MIKULASKO

PLANS BY
Bob Walker



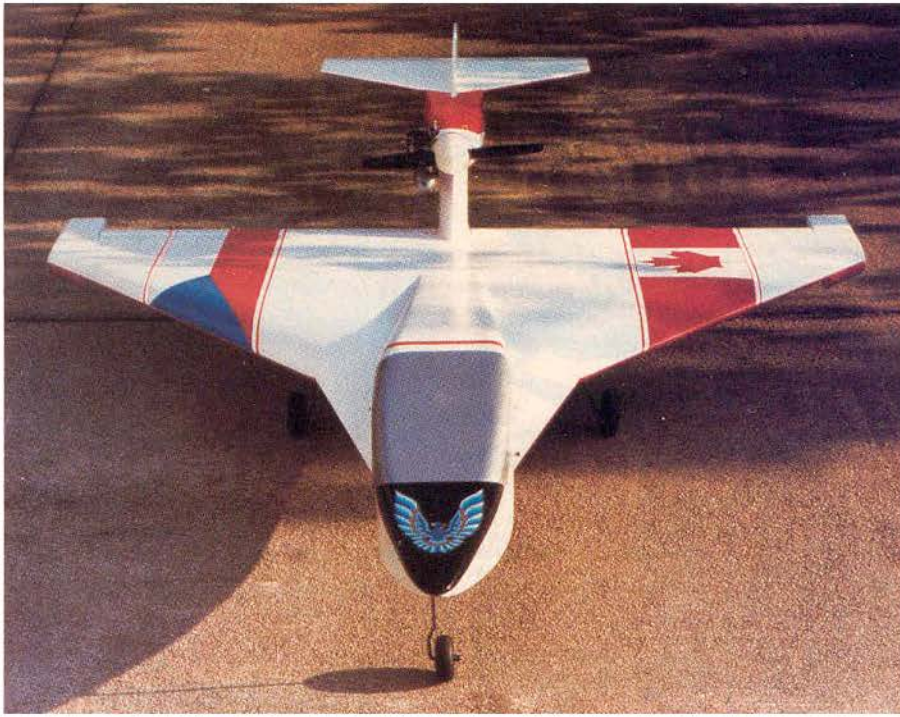

NORTH STAR

By Laddie Mikulasko

A few years ago, I was exposed to float planes at the local "float fly." I was hooked. I thought that this was the greatest thing for R/C flying; especially since the whole family can spend a pleasant day beside the water.

Watching the models taking off, and landing, and flying in general, I knew right away what kind of model I wanted to have. Since I have been flying delta winged models for years, I knew how well they performed. It was just natural for me to think of making a delta to fly off the water as well.

To achieve this goal proved to be a long educational process. I was on my own with the design that I had in mind. I couldn't find any reference material for this type of craft.

The first priority was to have the engine above the wing so that water spray couldn't get into the propeller. The "Force One" design (RCM March, 1982) was modified with the engine placed on a pylon above and behind the C.G. The model would not take off at all, because the thrust line of the engine was so high that it pushed the nose of the model down. No amount of

- NORTH STAR**
- Designed By:
Laddie Mikulasko
- TYPE AIRCRAFT**
Amphibian Sport Delta
- WINGSPAN**
44 Inches
- WING CHORD**
17" (Avg.)
- TOTAL WING AREA**
750 Sq. In.
- WING LOCATION**
Shoulder Wing
- AIRFOIL**
Symmetrical
- WING PLANFORM**
Delta
- DIHEDRAL EACH TIP**
None
- O.A. FUSELAGE LENGTH**
53 3/4 Inches
- RADIO COMPARTMENT SIZE**
(L) 10 3/4" x (W) 5" x (H) 2 1/2"
- STABILIZER SPAN**
17 Inches
- STABILIZER CHORD (incl. elev.)**
6" (Avg.)
- STABILIZER AREA**
102 Sq. In.
- STAB. AIRFOIL SECTION**
Flat
- STABILIZER LOCATION**
Mid-Rudder
- VERTICAL FIN HEIGHT**
14 Inches
- VERTICAL FIN WIDTH (incl. rud.)**
9" (Avg.)
- REC. ENGINE SIZE**
40-46 2-stroke
- FUEL TANK SIZE**
8-10 Oz.
- LANDING GEAR**
Tricycle (removable)
- REC. NO. OF CHANNELS**
4
- CONTROL FUNCTIONS**
Rud., Elev., Ail., Throt.
- BASIC MATERIALS USED IN CONSTRUCTION**
- Fuselage Balsa and Ply
- Wing Balsa and Spruce
- Empennage Balsa
- Wt. Ready To Fly 104 Oz. (6 1/2 Lbs.)
- Wing Loading 20 Oz./Sq. Ft.

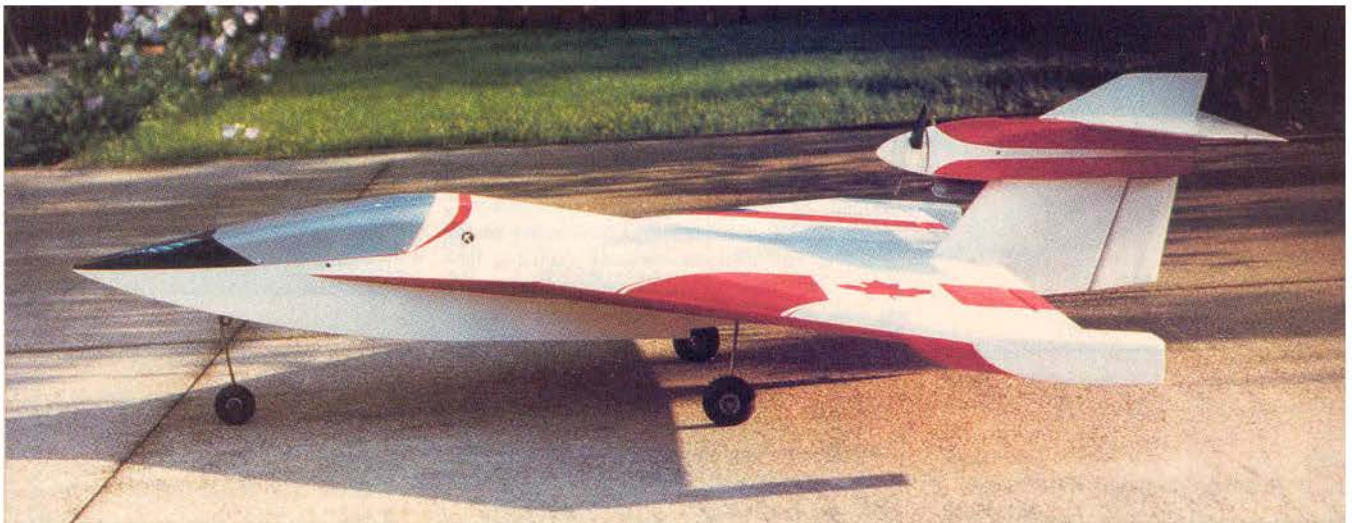

Once the North Star was airborne, Laddie knew he had his dream ship. The applause of his fellow modelers, together with the superb flying characteristics of the model, was the best reward he could receive for the time spent with developing this amphibian.

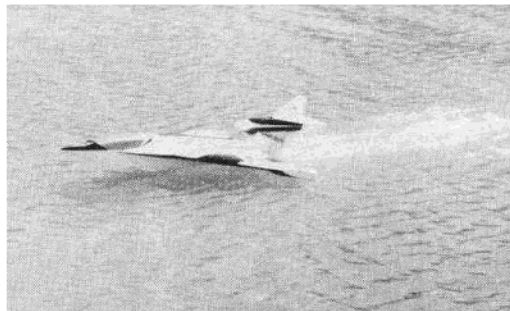

up elevator could overcome it.

After I destroyed the model trying to fly it, I built a modified version. A long program of crash damage and modification ensued.

Finally, the model took off, but before I had a chance to find out anything about its flight characteristics, the engine quit and the model fell down like a pancake onto its three wheels, destroying itself. I almost gave up.

Some months later, I started making new sketches, incorporating changes which I thought would be beneficial to the new model. I abandoned the pure delta wing configuration in favor of a delta winged model with a conventional tail. I enlarged the wingspan and area. Finally, I came up with the shape and configuration that I was satisfied with. I made up working drawings and a week before our Spring "Float Fly" I had a model ready to test fly.

After so many failures, I was very nervous as I taxied out (with shaky knees and a lump in my throat) in front of all of my friends.

The moment that I gave it full power, I relaxed. The model was picking up speed rapidly, with water spraying away from the wing tip floats. In no time it was skimming the surface of the lake and only a little up elevator was needed to get airborne.

Once in the air, I knew that I had my dream ship. The applause of my fellow modelers, together with the superb flying characteristics of the model, was the best reward for the time spent developing this model.

Looking back, I probably could have avoided some unnecessary steps in coming up with the final version if I had spent more time on research and less on cutting wood. In the end, though, I enjoyed the whole experience.

Since that time, I find that I fly this model more than any other that I

have. I never get tired of it. A number of other modelers in southern Ontario are now building and flying North Stars.

The reason that I am writing a little extra about the beginnings of the North Star is to caution the builder of this model to stick to the plan. If you think that changes here or there might enhance the appearance or flight characteristics, I urge you not to do it. In my development program, I found that each small change may have a drastic unwanted effect on the character of the model. I am not saying that nothing can be improved; far from it. Just have one "stock" model on hand first, against which you can compare those improvements.

The model, as shown, is an excellent flier in any weather conditions, and it flies equally well on land, snow or on the water. It is stable, maneuverable, and easy to handle. It flies well at high speed; yet can be flown very, very slowly without loss of control. In all, an excellent sport plane, with some unique versatility, and appearance.

Now, to the building of the North Star.

CONSTRUCTION

The North Star was designed to be as simple as possible. The drawing has all of the parts numbered for easy reference. The materials used are balsa, plywood, spruce and some fiberglass. No jigs are required to build the wings or fuselage. No great experience in scratch-building is needed. Just read the instructions, and refer to the exploded view drawing if in difficulty. Do not use water soluble glue.

You should be able to find all of the parts on the plan by checking their numbers.

Wing:

The wing is built first.

Cut out all of the ribs. Start by gluing together the spruce leading edge (1), wing tip pieces (2), and trailing edge (3) to form the triangular frame.

Mark the location of all of the ribs on the leading and trailing edge. When the frame is complete, lift the tip where the two leading edges are glued together, high enough so that you can glue all of the ribs into the frame. The trailing edge is left lying flat on the bench.

Next, glue the trailing edge sheeting (7) and spars (4) and leading edge filler (5) on this side. Flip the wing over and repeat the process on the other side. Sand the leading edge

filler to match the angle and contour of the ribs.

To ribs W2 and W3, glue in the matching plywood doublers W2 and W3. Now with epoxy glue, install the hardwood blocks (9) for the landing gear. Glue in the webbing between the spars (4).

The leading edge sheeting (6) can be glued next, together with the sheeting (27) in the center of the wing and the wing tip sheeting (28).

Glue on the cap strips (29) over the ribs.

Flip the wing over and do the same thing to this side.

Glue on the leading edge cap strip (8).

Sand the wing to your satisfaction. Make sure that the leading edge is blunt, as shown on the cut view A-A on the drawing.

Glue together the wing tip floats. Sand them and glue them to the bottom of the wing tips.

Trim the leading edge spruce (1) where the leading edge sheeting (6) starts. This part of the frame is not needed.

Now, make the ailerons out of 3/8" balsa trailing edge stock. The wing is now complete.

Fuselage:

Cut out the fuselage sides (13) and all other items needed to build it.

At the rear, glue to the right and left side the plywood doublers (19) and mark the location of all of the formers on the inside.

Next, glue on the balsa sheeting (26) to the outside of the plywood fin doublers (19).

Now, place the fuselage sides over the top view of the plan.

First, glue the rear-most post (22) and the fin's plywood spar (21), and then formers F5, F6 and F7. Check to make sure that the centerline of each former is on the centerline of the drawing. Let everything dry before proceeding.

Now, glue in formers F1, F2, F3 and F4. Before plywood former F2 is glue in, the brass tube is attached to it, to accommodate to nose gear leg later on. **Note:** It must be brass tubing, so that there is no chance for water to get in when the gear is removed and the model is flown from the water.

Glue in the triangular supports (52) on both sides of the plywood former F2, and the triangular stock (16) at the top

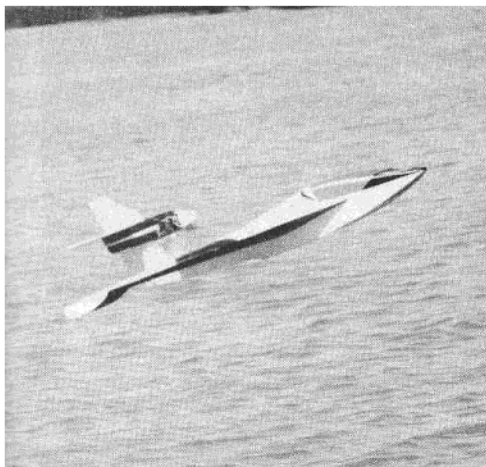

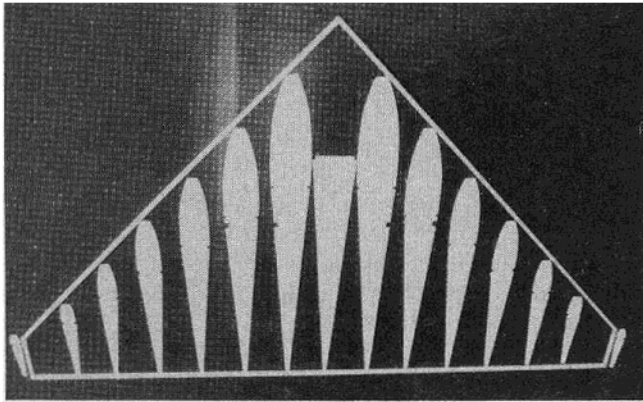

Layout of wing frame and all the ribs.

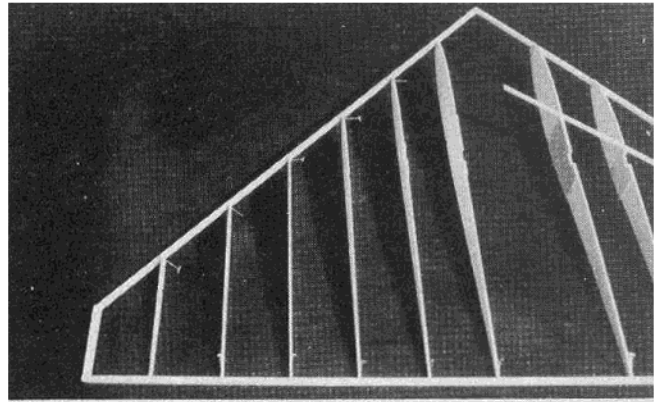

Ribs are glued into frame with the spar following next. Note the trailing edge is flat on the bench.

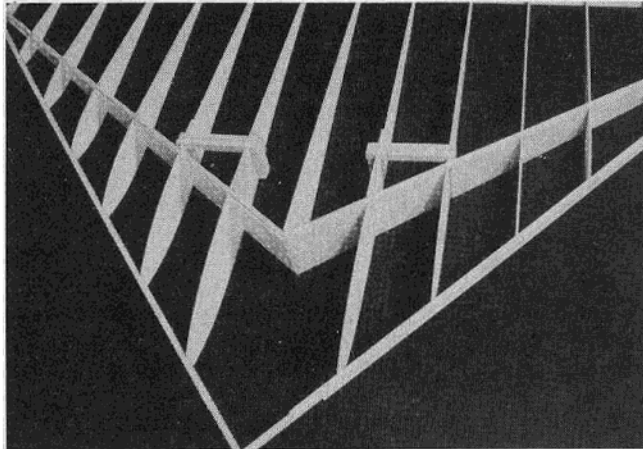

Trailing edge sheeting, landing gear blocks, leading edge fill and webbing now added.

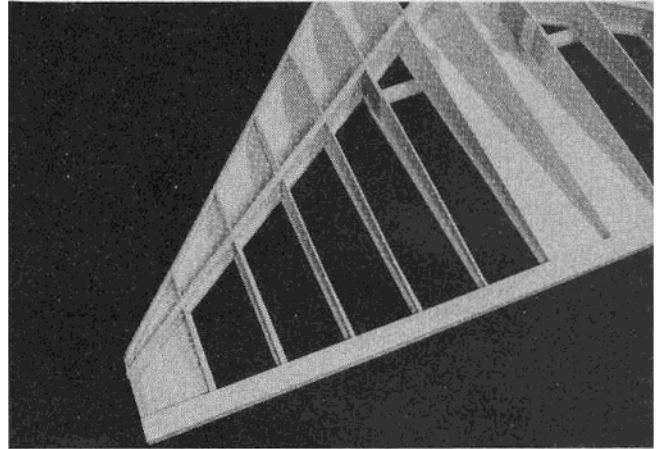

Center, tip and L/E sheeting added on bottom side. Blocks added to complete L/G mounts.

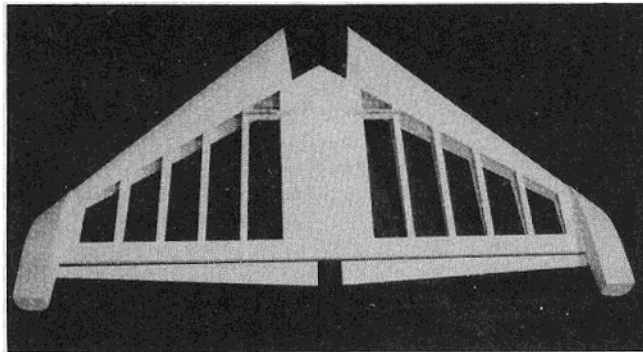

Wing tip floats are added to finished wing.

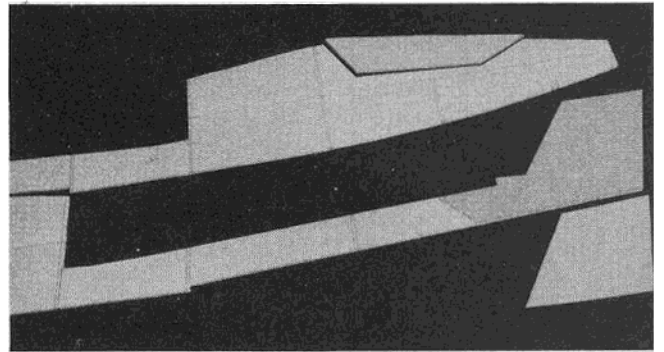

Fuselage sides cut out and fin doubler glued to them. Bulkhead placement lines marked on sides.

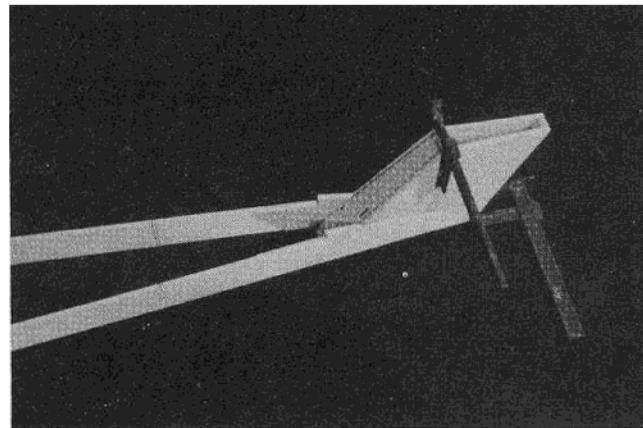

For this step, assemble fuselage sides over plans. Use clamps to hold together.

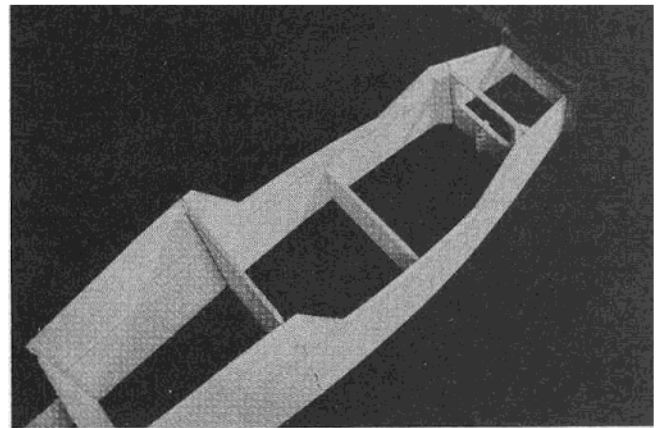

Front is pulled together using clamps. Note 5/32" i.d. brass tube is attached to F2 before installation.

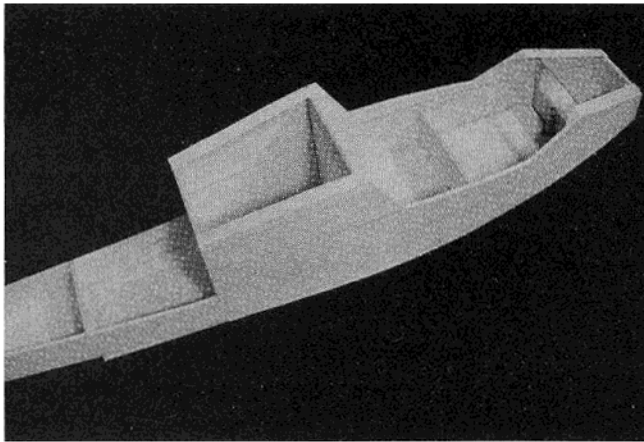

Triangle stock and bottom sheeting glued in place.

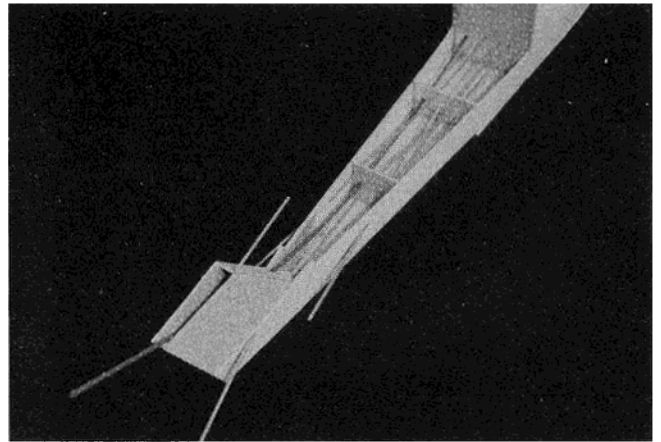

All Su-Pr-Line NyRods are installed and will be trimmed to correct length. Be sure to add one for receiver antenna.

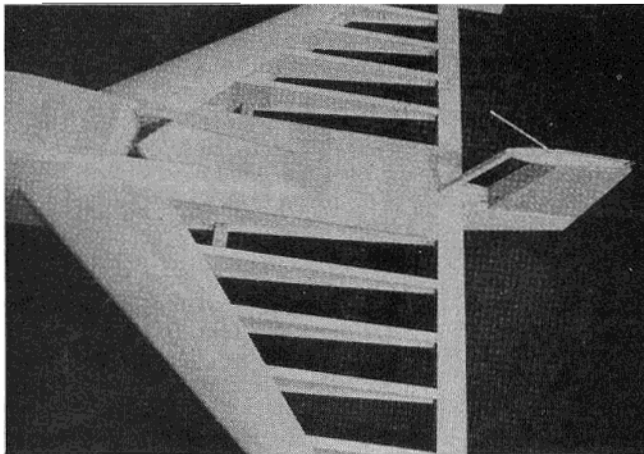

Wing is glued in place next with fin and fuselage fairing following.

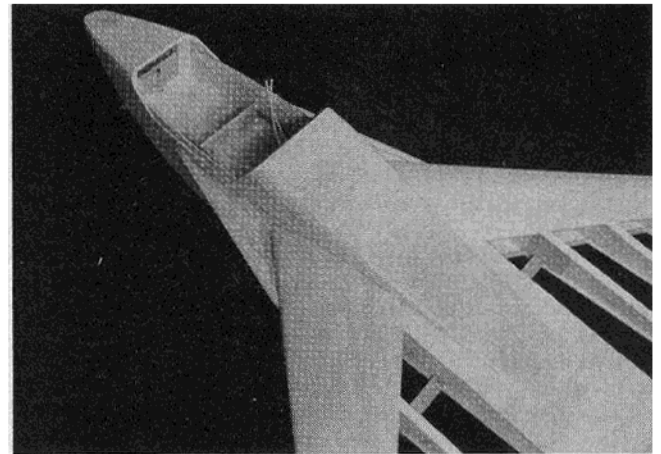

Wing root extensions added. Note NyRods protruding into cockpit area.

of the fuselage.

Glue on the bottom fuselage sheeting (18) and (14).

Feed all of the NyRods through all of the appropriate holes in the formers. All of the NyRods can be the cable type except for the elevator, where I suggest a stiffer NyRod. One outside NyRod tube is provided to house the radio antenna.

Next, the top fuselage sheeting (15)

and (32) is glued on.

Where the nose gear brass tube comes out, plywood plate (17) is inserted and glued in. Glue on the nose block (30). Sand the partially complete fuselage. Round off the corners at the top of the fuselage, but not at the bottom.

Now, take the wing and glue it to the fuselage.

Glue on the top fuselage fairing by

gluing sides (31), triangular stock (16) and top sheeting (32).

At the rear, the fin has to be finished. Glue on the bottom half rib P2 to the wing rib P1 at the top of the fin. Add leading edge support (24) and then sheet both sides with 1/8" balsa (26). Finish by gluing on leading edge cap strip (25).

Finish sanding the fuselage and fin.

At the radio compartment, glue in

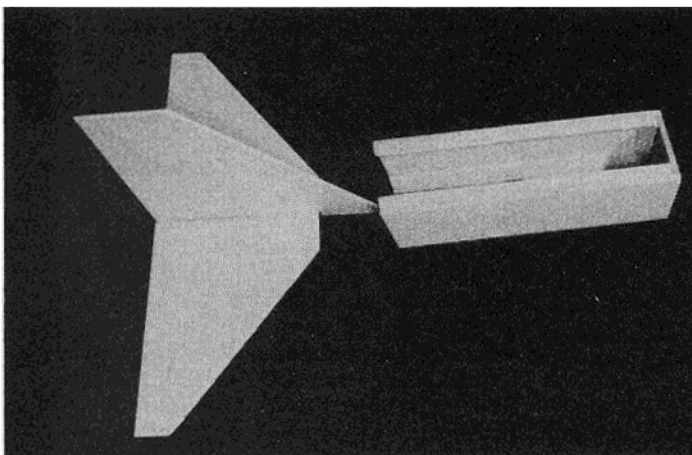

Engine pod assembled ready for tail group to be attached.

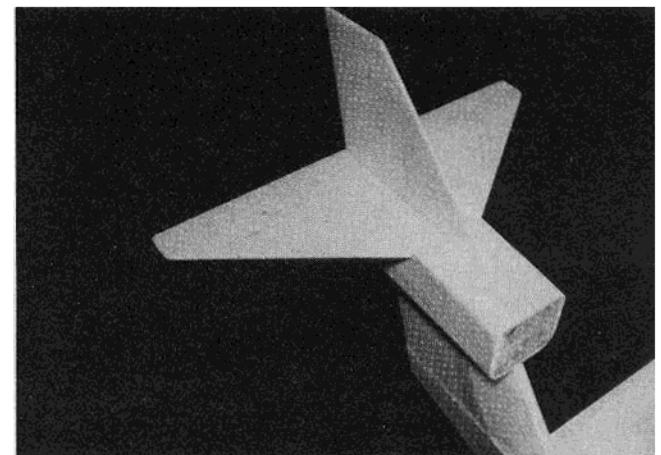

Tail group and engine pod is glued on top of fin. This area can now be fiberglassed.

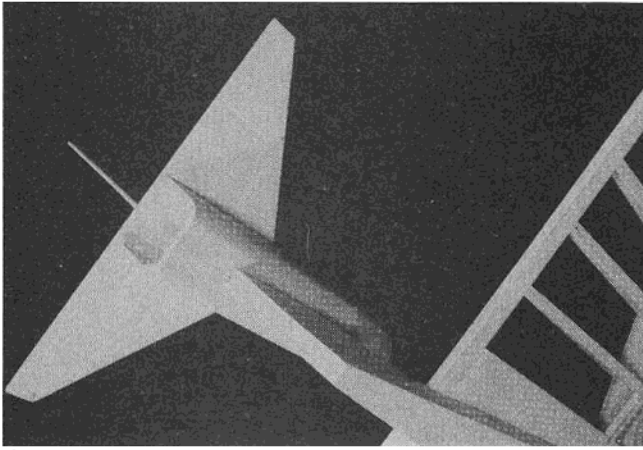

Looking at bottom view of tail group. Note NyRod for elevator. Fiberglass engine cowl has been made.

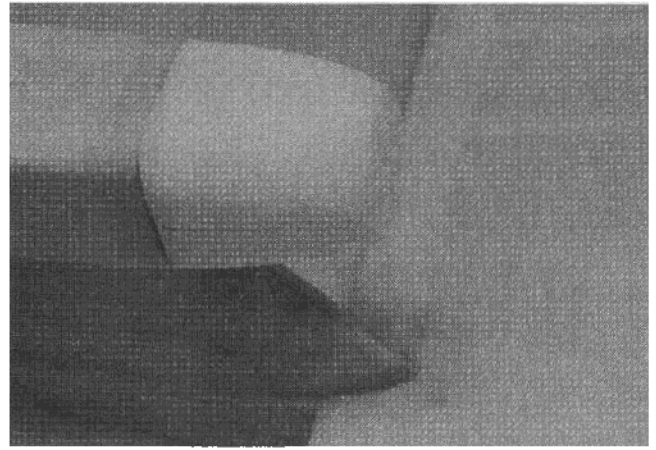

After fin was fiberglassed, foam block was glued to the firewall and shaped. Glass cloth was then laid over foam with epoxy to form cowl.

the plywood strips (49) for seating the hatch. Make the hatch.

Add the wing root leading extensions (12). These are made from 1/16" hard balsa and balsa support stock (50). Make sure that this leading edge is sharp, as shown on a cutaway section B-B.

Assemble the engine pod by gluing triangular stock (37) to the sides (34) and then installing the firewall E1 with all of the holes for fuel lines and engine mount drilled ahead of time. I suggest that you use blind nuts for the engine mount.

Glue bottom sheeting (35) and top sheeting (36) to it.

Glue on the stabilizer (37). On top of the stabilizer and engine pod, glue the fin extension (38). Cut openings in the bottom of the engine pod for the elevator and throttle NyRods to come through. Sand this assembly and then glue it to the top of the fin. Make sure that everything is aligned with the rest of the model.

Next, you should fiberglass this rear area on both sides, starting from the

bottom area of the engine pod, down to the bottom edge of the fuselage. Use two layers of approximately 2 oz. cloth. Fiberglass the bottom of the fuselage and the bottom of the wing tip floats with two layers of cloth as well.

This is done so that when taxiing the plane onto shore, stones will not damage the bottom.

Seal the inside of the radio compartment and engine pod with dope or resin.

You should make a cowl for the engine. Use balsa or fiberglass to make one. A cowl will greatly improve the appearance of the model.

Covering the model is next. Do not use plastic covering; as it would be difficult to make it waterproof around the seams. You should cover all of the balsa sheeted surfaces as well.

Install all of the hinges. Make sure that there are no unsealed holes around the hinges, so that water cannot seep into the wing or fuselage.

Paint the model in your favorite finish.

When painting is finished, install

the radio, landing gear, engine, and fuel tank. A 10 oz. tank is maximum, due to the affect on C.G.

The fuel tank is secured in place with soft foam. The receiver battery has to be placed in front of former F2.

Check the C.G. with the fuel tank empty. I know that you will have to add some lead in the battery compartment. How much will depend on the weight of the engine and how light the balsa was that was used in the tail area. Don't worry — the model has plenty of wing area to support this extra weight.

Do not fly the model with the C.G. behind the location shown on the plan.

Flying:

On Land: Once you have checked your controls, fuel up and run your engine. You should have your propeller balanced so that there is no excess vibration. The model should sit on its wheels as shown on the drawing.

Taking off is a simple matter of pointing the nose into the wind and applying full power. On the first few take-offs, try to keep the elevator level until the model is rolling at high speed. Then, add up elevator for rotation and lift-off.

After several familiarization flights, you can hold full up elevator right from the start. The model will only lift off if it has flying speed, and at that time it will be rock steady.

Once in the air, you will be surprised at how stable the model is at any speed. The model can do any maneuver that a conventional model can do, except spin. It will also do one maneuver that conventional models cannot do; and that is controllable vertical descent. With practice, you can hold the model nose high and use throttle to adjust the vertical descent rate, when the forward speed is near zero. At that speed, the wing will rock from side to side, but you will have full control with elevator and ailerons to make corrections.

You can land like that on water, but

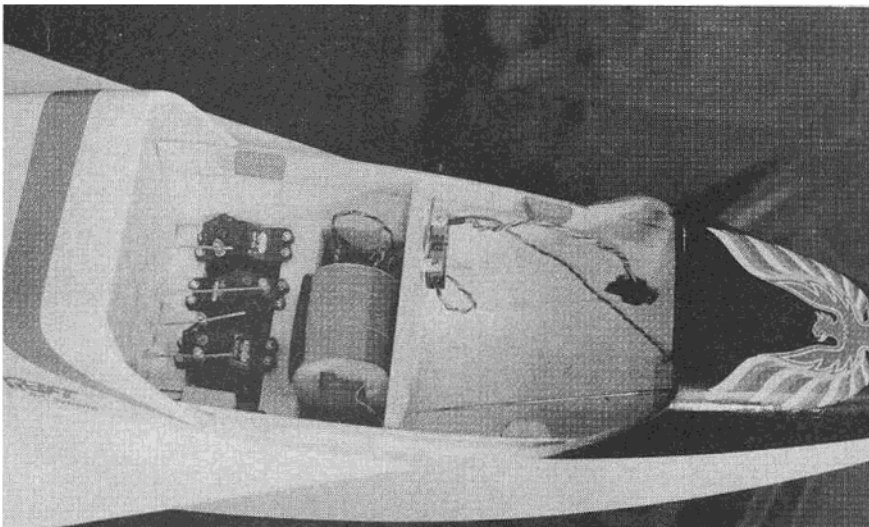

Radio gear installed in cockpit area. Servos could go farther forward than shown here — would help the balance. Note small wood blocks inside for wood screws that hold the hatch.

COMPONENT PARTS LEGEND			
NO.	SIZE	MATERIAL	LOCATION
1	1/4" SQ.	SPRUCE	WING
2	1/4" SQ.	SPRUCE	WING
3	1/4" SQ.	SPRUCE	WING
4	1/8" X 1/4"	SPRUCE	WING
5	3/16" X 1/4"	BALSA	WING
6	3/32" SHEET	BALSA	WING
7	3/32" SHEET	BALSA	WING
8	1/8" X 1/2"	BALSA	WING
9	3/8" X 1/2"	HARDWOOD	WING
10	1/8" SHEET	BALSA	FLOAT
11	1/8" SHEET	BALSA	FLOAT
12	1/16" SHEET	BALSA	WING ROOT
13	3/16" SHEET	BALSA	FUSELAGE
14	1/8" SHEET	BALSA	FUSELAGE
15	1/8" SHEET	BALSA	FUSELAGE
16	1/2" Δ STOCK	BALSA	FUSELAGE
17	1/8" SHEET	PLYWOOD	FUSELAGE
18	3/32" SHEET	BALSA	FUSELAGE
19	1/16" SHEET	PLYWOOD	FIN
20	1/4" X 5/16"	BALSA	RUDDER
21	1/8" SHEET	PLYWOOD	FIN
22	1/4" X 3/8"	BALSA	FIN
23	1/8" SHEET	BALSA	FUSELAGE
24	1/4" X 1/2"	BALSA	FIN
25	1/8" X 5/16"	BALSA	FIN
26	1/8" SHEET	BALSA	FIN
27	3/32" SHEET	BALSA	WING
28	3/32" SHEET	BALSA	WING
29	3/32" X 1/2"	BALSA	WING
30	BLOCK	BALSA	FUSELAGE
31	3/16" SHEET	BALSA	FUSELAGE
32	1/8" SHEET	BALSA	FUSELAGE
33	1/2" Δ STOCK	BALSA	ENGINE POD
34	1/4" SHEET	BALSA	ENGINE POD
35	1/4" SHEET	BALSA	ENGINE POD
36	1/4" SHEET	BALSA	ENGINE POD
37	1/4" SHEET	BALSA	STABILIZER
38	1/4" SHEET	BALSA	TOP FIN
39	1/4" SHEET	BALSA	ELEVATOR
40	3/32" SHEET	BALSA	RUDDER
41	1/8" SHEET	PLYWOOD	RUDDER
42	1/8" SHEET	BALSA	RUDDER
43	1/4" SHEET	PLYWOOD	RUDDER
44	1/8" SHEET	BALSA	RUDDER
45	1/8" SHEET	BALSA	FLOATS
46	1/8" SHEET	BALSA	FLOATS
47	1/8" SHEET	BALSA	FLOATS
48	1/2" Δ STOCK	BALSA	FLOATS
49	1/16" SHEET	PLYWOOD	FUSELAGE
50	1/8" X 1/4"	BALSA	WING ROOT
51	3/8" X 2"	BALSA	AILERON-STOCK
52	1/2" Δ STOCK	BALSA	FUSELAGE
53	1/16" SHEET	BALSA	WING
54	3/16" SHEET	BALSA	FUSELAGE
W-1	3/32" SHEET	BALSA	WING
F1	1/4" SHEET	BALSA	FUSELAGE
F2	1/4" SHEET	PLYWOOD	FUSELAGE
F3-F7	1/8" SHEET	BALSA	FUSELAGE
PI-P2	1/8" SHEET	BALSA	FIN
E1	1/4" SHEET	PLYWOOD	ENGINE POD

BUILDING MATERIAL REQUIREMENTS

- | | |
|---|---|
| 14 - 3/32" X 3" X 36" BALSA SHEETS | 1 - 1/16" X 12" X 10" PLYWOOD |
| 3 - 3/16" X 4" X 48" BALSA SHEETS | 4 - 1/4" X 1/4" X 36" SPRUCE |
| 4 - 1/2" Δ STOCK X 36" BALSA | 4 - 1/8" X 1/4" X 36" SPRUCE |
| 1 - 1/4" X 4" X 7" PLYWOOD | 2 - 3/8" X 1 1/2" X 36" BALSA TRAILING EDGE STOCK |
| 2 - 1/4" X 4" X 36" BALSA SHEETS | 1 - 1/16" X 3" X 36" BALSA SHEET |
| 3 - 1/8" X 4" X 36" BALSA SHEETS | 1 - 5/32" DIA. X 36" MUSIC WIRE |
| 1 - 1/4" X 2" X 36" BALSA TRAILING EDGE STOCK | |

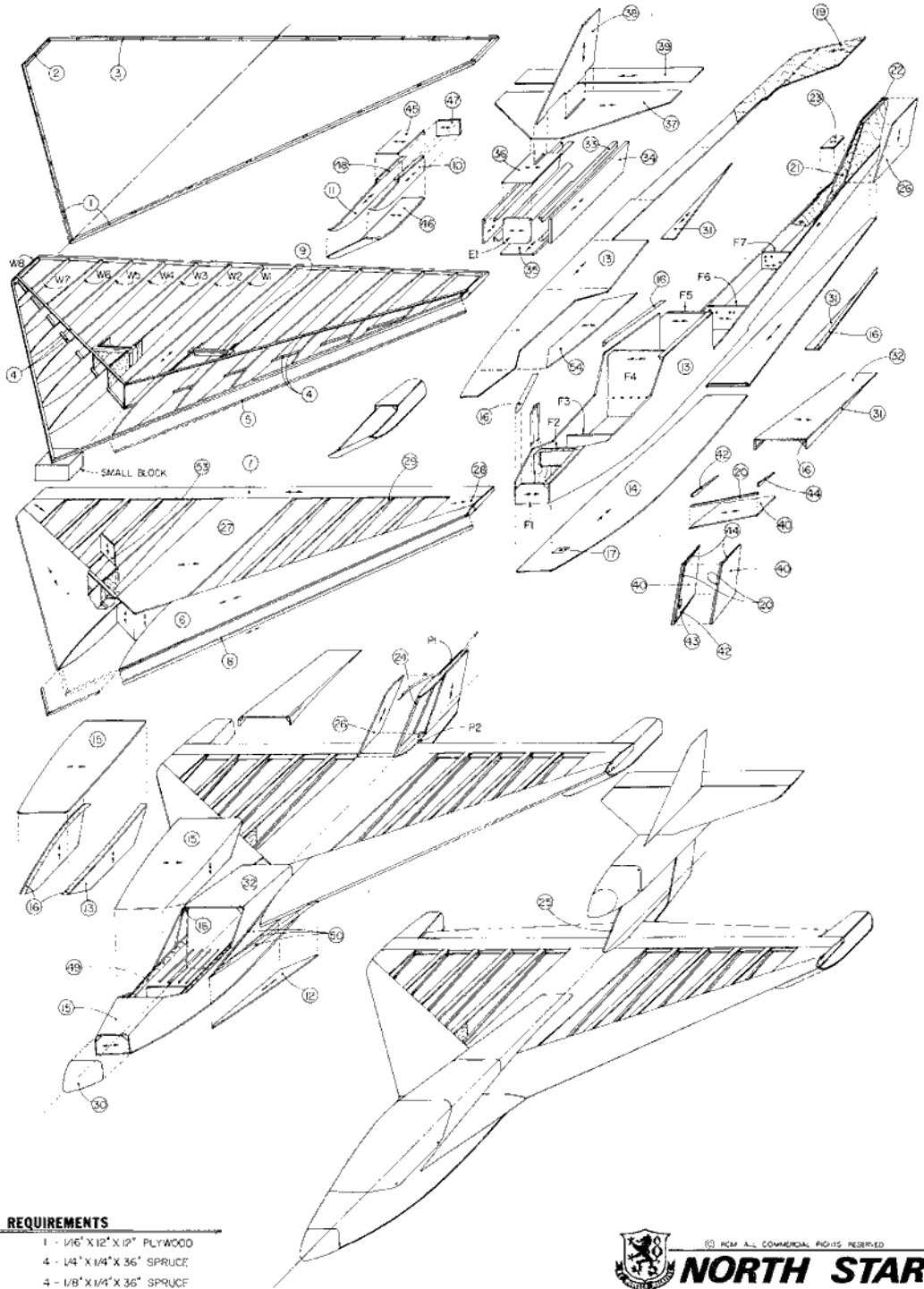

© 1964 N.S. COMMERCIAL RIGHTS RESERVED

NORTH STAR

A 40-46 POWERED SPORT AMPHIBIAN DESIGN

DESIGNED & DRAWN BY LADDE MIKULASKO PLANS BY *Ladde Mikulasko*

0 1 2 3 4 5 6

SHEET 3 OF 3

PLAN NO. 960

I don't recommend doing it on land as it is easy to put the wheel through the bottom if you misjudge the descent rate.

If you want to stop the descent, just add power and the model will accelerate forward with a slight drop of the nose.

A conventional landing approach will result in a conventional landing.

On Water: Just remove the landing gear. You don't have to plug any holes. If you desire more steering power, add a water rudder to the bottom of the rudder. Without this water rudder, the rudder by itself is capable of

making turns of about 30 ft. radius.

Check the reliability of your engine's idle. Have some way of retrieving the model in case of engine failure. Check the range of the radio.

The take-off on water is as good, or even better as the take-off on land. Taxi into the wind and open up the

throttle. The model will track straight with not a drop of water hitting the propeller. Even if you do nothing, the model will try to leave the surface of the water by itself since, as the speed builds up, air is compressed under the wing between the fuselage and the wing tip floats, creating an air cushion effect. You'll be the envy of every hydroplane driver on the lake. A small amount of up elevator will cause the model to leave the surface smoothly. The model can handle rougher surfaces than any other float plane.

Once in the air, the clean lines of the model will really show; especially since the landing gear was removed. Because of its clean lines, it doesn't want to slow down much when coming in for landing. Before the fuel runs out, you should make a few practice landing approaches. To land where you want, cut the throttle and raise the nose until you see the model has a tendency to rock the wings. Then, just add a little power and control the speed of descent with power.

As soon as the rudder and wing tips touch the water, the model is "glued" to the surface. I know that after a while you will be doing take-offs and landings ten times as often on water as on land.

I hope that I have excited you enough to build this model, and fly it in both environments. I wish you long and happy flying hours with the North Star.

A kit is available for the North Star in a foam and fiberglass version. For more information, contact: Bob Parkinson Flying Models, 7080 Copenhagen Rd., Unit 24, Mississauga, Ontario, Canada L5N 2C9. Tel. (416) 826-2277.

□

**From
RCModeler
Mar. 1986**

